



Dependable Products From People You Trust



HTHP Filter Press with Threaded Cells for Cement Testing

**#171-192: 115 Volt
#171-192-1: 230 Volt**

Instruction Manual

**Updated 10/10/2019
Ver. 6**

OFI Testing Equipment, Inc.
11302 Steeplecrest Dr. · Houston, Texas · 77065 · U.S.A.
Tele: 832.320.7300 · Fax: 713.880.9886 · www.ofite.com

©Copyright OFITE 2014

Table of Contents

Introduction.....	2
Specifications	2
Components	3
Safety.....	5
Quick Start	6
Operation.....	9
Data.....	14
Cell Cap Assembly	15
Maintenance.....	16
Diagrams	18
<i>Dual Nitrogen Manifold</i>	<i>18</i>
<i>Test Cell</i>	<i>19</i>
Warranty and Return Policy	20

Introduction

The OFI Testing Equipment (OFITE) High Temperature High Pressure (HTHP) Filter Press is designed to evaluate the filtration characteristics of drilling fluids, cement slurries, fracturing fluids, and completion fluids under elevated temperatures and pressures. Evaluating fluids under HTHP conditions similar to the downhole environment is of paramount importance. Fluid properties must be monitored while under high temperatures and pressures as filtration behavior and wall cake building characteristics of permeable formations change with changing environments. These characteristics are affected by the shape, type, and quantities of solids present in the fluid and their physical and electro-chemical interactions, all of which are affected by changing temperatures and pressures. The complete assembly consists of the following:

- A controlled pressure source (Not included)
- Two Nitrogen pressure regulators (primary and back pressure)
- A high-pressure test cell
- A heating jacket for heating the test cell
- A suitable stand

Specifications

Size:	8" × 12" × 30" (20 × 30 × 76 cm)
Weight:	53 lbs (24.1 kg)
Maximum Temperature:	500°F (260°C)
Maximum Pressure:	5,000 PSI (34.5 MPa)
Pressure Source:	Nitrogen (at least 1500 PSI / 10,343 kPa)
Test Cell Capacity:	500 mL
Heater:	800 Watt

Components

- #153-12 Graduated Cylinder; 100 mL × 1 mL; Glass
- #154-20 Thermometer with Metal Dial, 8" Stem, Dual Scale: 50° - 500°F / 0° - 250°C
- #165-44-2 Anti Seize Compound, Silver, 7g Pouch
- #170-13-3 O-ring for Test Cell, Viton®, Qty: 6
- #170-17 O-ring for Valve Stem, Viton®
- #170-35 6" Adjustable Wrench

- #171-00 Heating Jacket (115 Volt)
- #171-01 Heating Jacket (230 Volt)

#171-10 Back Pressure Receiver; 100 mL:

- #170-32 Needle Valve, Male, 1/8" × 1/8"
- #171-11 O-ring for 100-mL Back Pressure Receiver
- #171-12 Receiver Body
- #171-23-1 Safety Pin with Lanyard

#171-192-S Test Cell, Stainless Steel (For Cement Testing)

- #120-910-028 O-ring for Rupture Disk, Viton
- #130-81-040 Retaining Ring, Qty: 2
- #170-13-3 O-ring for Cell, Viton, Qty: 4
- #170-16 Valve Stem, Qty: 2
- #170-17 O-ring for Valve Stem, Viton, Qty: 4
- #170-18 Cement Screen, Removable, Qty: 2
- #171-190-020-S Cell Body
- #171-190-023 Locking Ring, Qty: 2
- #171-190-027 Rupture Disk, 7500 PSI, Qty: 2
- #171-190-029 Cell Cap Wrench
- #171-190-032-S Cell Cap for Cement Testing, Outlet
- #171-190-033-S Cell Cap for Cement Testing, Inlet
- #171-190-057 O-ring for Valve Stem, Viton 90D, Qty: 4
- #171-190-058 O-ring for Rupture Disk, Viton 90D, Qty: 1
- #171-190-060 O-ring for Cell, Viton 90D, Qty: 4

#171-24 Dual Nitrogen Manifold, 1350 & 750 PSI

- #170-20 Manifold Block
- #170-32 Needle Valve, Male, 1/8" × 1/8" NPT
- #171-23-1 Safety Pin with Lanyard
- #171-24-001 Regulator, Modified, Qty: 2
- #171-25-1 Relief Valve, Set at 750 PSI
- #171-25-2 Relief Valve, Set at 1,350 PSI
- #171-26 Hose, 5000#, 3/16" × 3'
- #171-28 Body
- #171-38 Gauge, 1000 PSI
- #171-40 Gauge, 1500 PSI
- #171-42 Gauge, 3000 PSI

Optional:

- #170-37 Nitrogen Cylinder, 21" × 7", Right-hand Thread
- #170-33 Cell Cap Removal Tool
- #170-40 Carrying Tool for HTHP Cell
- #170-91 HTHP Pressure Relief Tool
- #171-06 Safety Shield

#171-192-SP Spare Parts Kit:		
Part Number	Description	Qty.
#130-81-040	Retaining Ring	2
#143-00-1	Diaphragm For Airco Regulator	2
#143-07	Repair Kit for Regulator (#143-00)	2
#153-12	Graduated Cylinder, 100 mL × 1 mL	2
#153-14	Graduated Cylinder; 50 mL	2
#154-20	Dial Thermometer, 8" Stem, 50° - 500°F and 0 - 250°C	1
#165-44-1	High Temp Thread Lubricant 4 Oz.	2
#170-05	Thermostat For HTHPFP 50-500	1
#170-10	Thermostat Pilot Light	1
#170-11	Heating Element 115V-200W	2
#170-13-3	O-ring for Test Cell, Viton®/Fluorocarbon (FKM)	50
#170-16	Valve Stem	4
#170-17	Valve Stem O-ring	100
#170-19	Filter Paper, 2½" (6.35 cm), Hardened for Filter Press	10
#171-11	O-ring, -028, Nitrile 70D	6
#171-23-1	Safety Pin with Lanyard	2
#171-190-057	O-ring for Valve Stem, Viton 90D	100
#171-190-060	O-ring for Cell, Viton 90D	50

**Note**

Spare parts listings are intended to be used as a reference for future purchases. Everyone's consumable requirements will be different, and replacement quantities needed will depend upon the number of test performed on a daily and/or weekly basis.

Safety

Read this manual carefully before attempting to use the equipment. Improper use can result in injury or damage to the equipment.

Temperature

The heating jacket, test cell, and valve stems will be very hot during testing. Handle these components with care. Never touch hot components without wearing protective clothing.

At elevated temperatures, the fluid in the test cell will expand. Never fill the test cell completely with fluid. The API recommends leaving at least 2" of void space to allow for thermal expansion.

Pressure

Always pressurize with either Carbon Dioxide or Nitrogen. Do not use Nitrous Oxide (NO₂), Oxygen (O₂), or compressed air. These gasses are dangerous at elevated temperatures.

The maximum working pressure of the test cell (5,000 PSI / 34.5 MPa) is marked on the cell body and cap. Never exceed this pressure.

Equipment

Inspect all o-rings before every test. Discard any that show signs of damage or wear. Look for nicks, cuts, or brittle o-rings. Two sets of o-rings are included with the Filter Press. The first set is made from Viton 75D. These o-rings are black and should be used for tests up to 400°F only. The second set is made from Viton 90D. These o-rings are green and should be used for tests up to 500°F.

The Safety Pin includes an attached lanyard. The lanyard secures the pin and prevents it from accidentally disengaging from the valve stem and pressure assembly. Always secure the pin with the lanyard.



Retainer Pin with Lanyard



Safety Retainer Pin with Lanyard
(# 171-23-1)

Cell Corrosion

Test fluids under high temperature and pressure can corrode the cell body and caps. Carefully inspect the cell body and caps for corrosion before and after each test.

Some materials are more susceptible to corrosion than others. Also, some fluids and additives are more corrosive than others. OFITE offers a variety of cell materials for different levels of corrosion resistance and cost.

Quick Start

1. Place the thermometer in the heating jacket.
2. Preheat the heating jacket to 10°F (6°C) above the test temperature. The pilot light will turn on at the target temperature.
3. Inspect all o-rings. Replace any that show signs of damage or wear.
4. Apply grease to all o-rings.
5. Assemble both cell caps. Place an o-ring in the groove around the cap.
6. Make sure all threads are clean and free of debris.
7. Apply anti seize compound (#165-44-2) to the threads of the cell locking rings and valve stems.
8. Place cement screen on top of the o-ring.
9. Screw the inlet cell cap into the cell and tighten it completely.
10. Screw a valve stem into the inlet cell cap and tighten it completely.
11. Pour the test fluid into the cell. Leave adequate space for fluid expansion.
12. Place an o-ring in the groove inside the cell.
13. Place a cement screen on top of the o-ring.
14. Screw the outlet cell cap into the cell. Tighten it completely.
15. Screw a valve stem into the outlet cell cap and tighten it completely.
16. Invert the cell and place it in the heating jacket. Rotate the cell until it seats.
17. Transfer the thermometer to the cell body.
18. Connect the manifold block from the dual Nitrogen manifold to the top valve stem and secure it with the safety pin.
19. Screw the hose from the dual Nitrogen manifold into the back pressure receiver.
20. Connect the back pressure receiver to the bottom valve stem and secure it with the safety pin.
21. Connect a Nitrogen cylinder to the dual Nitrogen manifold.
22. Adjust both regulators to the target back pressure for the test.

23. Open the top valve stem $\frac{1}{2}$ turn.
24. After heat time, increase the top pressure to 500 PSI above the back pressure.
25. Open the bottom valve stem to initiate filtration.
26. Collect filtrate and record the volume at 1, 7.5, and 30 minutes.
27. After 30 minutes, close both valve stems.
28. Turn both regulator T-screws counterclockwise.
29. Open the outlet valve on the back pressure receiver to collect any remaining filtrate.
30. Open the valve on the manifold block to release any remaining pressure.
31. Remove the manifold block and back pressure receiver.
32. Allow the cell to cool to room temperature.
33. Remove the cell from the heating jacket. Keep the outlet side pointing down.
34. Slowly open the valve stem on the inlet side to release the pressure.
35. Unscrew the outlet cell cap.
36. Wash the filter cake and record the thickness to the nearest $\frac{1}{32}$ ".
37. Clean and dry all components.

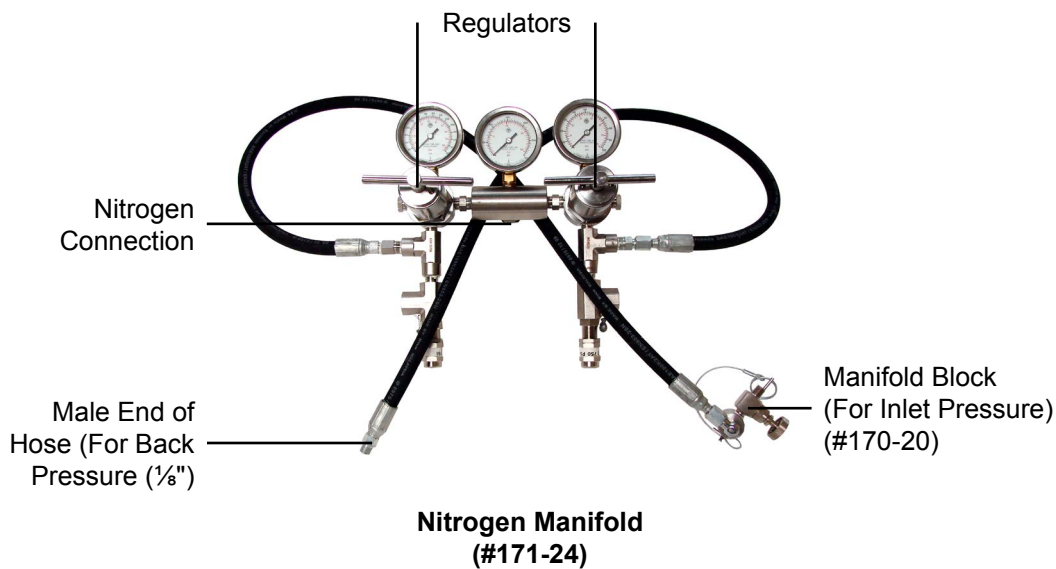
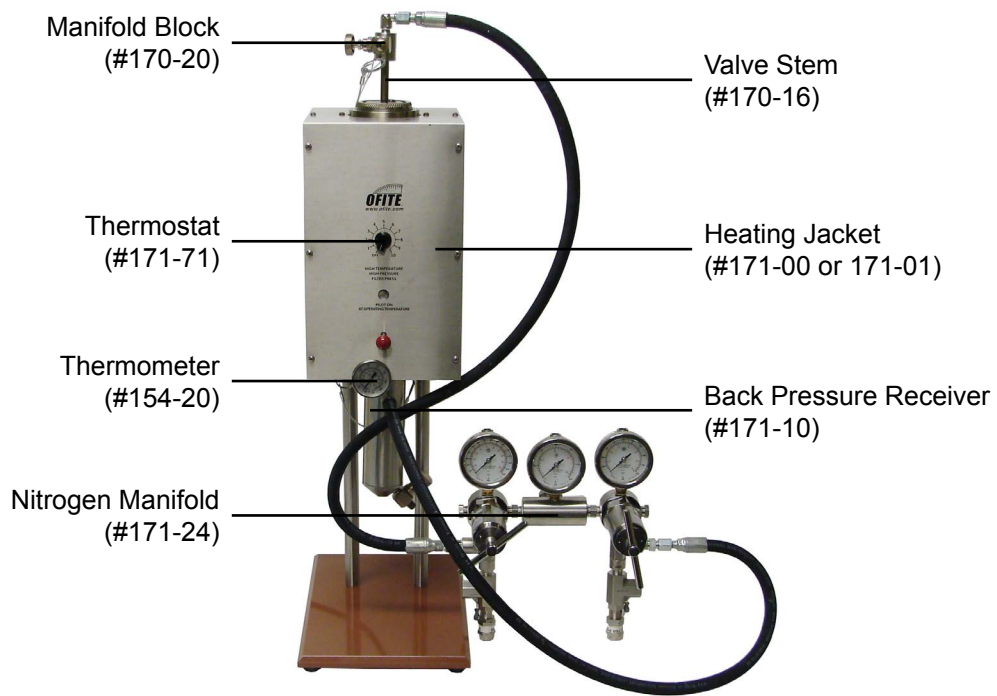

Operation

1. Plug the heating jacket into an appropriate power source. Place a thermometer (#154-20) into the heating well and preheat to 10°F (6°C) above the test temperature. A pilot light will come on when the heating jacket reaches the temperature set by the control knob.
2. If the cell caps are not already assembled, see page 15 for assembly instructions.
3. Inspect the cell cap and cell body. Discard any components that show signs of corrosion, damage, or wear.
4. Inspect all o-rings. Replace any that show signs of damage or wear. Looks for nicks, cuts, or brittle o-rings. Replace all o-rings after any test above 350°F (176.7°C). Place a thin film of silicone grease on all o-rings.
5. Make sure all threads are clean and free of debris.



O-ring

Valve Stem
(#170-16)

O-ring

6. Place an o-ring (#170-13-3) on the shoulder inside the cell body on the end marked "In". Place another o-ring in the groove around the cell cap.

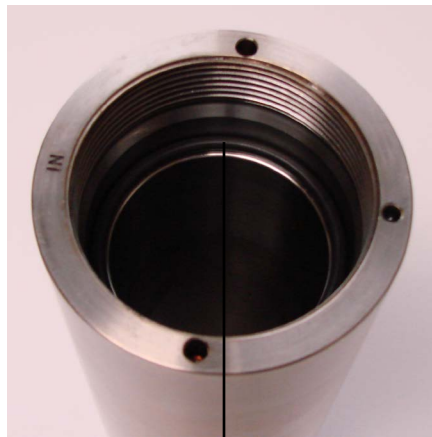

O-ring



Cement Screen
(#170-18)

7. Place a cement screen on top of the o-ring.
8. Apply anti seize compound (#165-44-2) to the threads of the cell locking rings and valve stems.



9. Screw the inlet cell cap into the cell body.

The cell cap should turn smoothly in the threads and not require any tools for complete tightening. If you encounter resistance, carefully unscrew the cap and start over. Make sure the threads are properly seated before tightening completely.

10. Place an o-ring in each of the two o-ring grooves on both valve stems.

11. Screw one valve stem into the inlet cell cap. Tighten the valve stem completely.



To increase the life of the valve stem and cap, apply a thin layer of high-temperature thread lubricant (#165-44-1) to the tip of the valve stem.

12. Prepare the test fluid.

13. Invert the cell body and carefully pour the sample into the cell. Leave 2" (5.1 cm) void space for thermal expansion.



Be careful not to spill fluid on the o-ring shoulder inside the cell.

14. Place an o-ring in the cell and another on the cell cap.

15. Place a cement screen on top of the cell o-ring.

16. Screw the outlet cap into the cell body.

17. Screw the other valve stem into the outlet cell cap and tighten it completely.

18. Invert the cell and place it in the heating jacket with the outlet (filter) side pointed down. Rotate the cell in the heating jacket so that the pin in the bottom of the heating well seats into the hole in the bottom of the test cell. This will anchor the cell in the well and prevent it from rotating as the valve stems are opened and closed.

19. Move the thermometer from the heating jacket to the hole in the test cell.



Allow the cell to heat for one hour. Start a 60 minute timer now.



Important

20. Connect the manifold block from the dual Nitrogen manifold to the top valve stem and lock it in place with the safety pin. Place the back pressure receiver on the bottom valve stem and lock it in place with the safety pin.

The Safety Pin includes an attached lanyard. The lanyard secures the pin and prevents it from accidentally disengaging from the valve stem and pressure assembly. Always secure the pin with the lanyard.

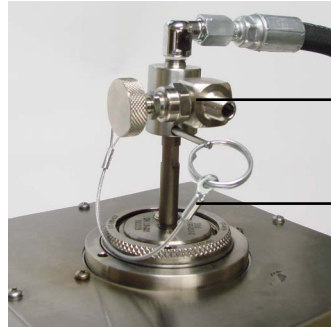

Manifold Block (#170-20)
Safety Pin (#171-23-1)

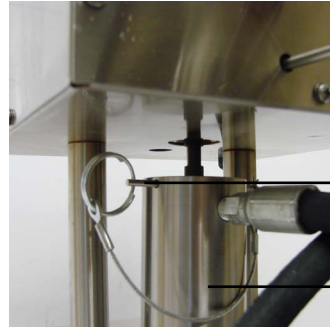

Safety Pin (#171-23-1)
Back Pressure Receiver (#170-11)

21. Connect the male end of the pressure hose to the back pressure receiver (if it is not already connected). Make sure the needle valve on the back pressure receiver is closed.

22. Unscrew the regulator T-screws (counterclockwise) on the pressure manifold to make sure both regulators are completely closed.

23. Connect a Nitrogen cylinder (at least 1,500 PSI) to the center inlet on the pressure manifold. Open the pressure release valve on the nitrogen bottle and note the bottle pressure as registered on the middle manifold gauge.

24. Keeping the valve stems closed, adjust the top and bottom regulators to the recommended **back pressure** for your test (see chart below). Make sure the ball valves and bleeder valves are all closed.

The upper and lower limits of the test pressure differential are determined by the test temperature. As this temperature exceeds 212°F (100°C), the back pressure must be increased in order to prevent vaporization of the filtrate. The 500 PSI differential pressure must be maintained, so the top pressure will have to be increased accordingly. The table below shows the pressures recommended for various test temperatures.



Note

Recommended Minimum Back Pressure					
Test Temperature		Vapor Pressure		Minimum Back Pressure	
°F	°C	psi	kPa	psi	kPa
200-299	95-149	12.1-67	84-462	100	700
300-374	150-189	67-184	462-1269	200	1400
375-399	190-199	184-247	1269-1704	275	1900
400-424	200-219	247-326	1704-2245	350	2500
425-450	220-230	326-422	2245-2912	450	3100

25. Open (loosen) the top valve stem $\frac{1}{2}$ turn to pressurize the sample. Maintain this pressure on the fluid until the temperature has stabilized.
26. After the one hour heat up time, increase the pressure on the top pressure unit to 500 PSI (3,448 kPa) more than the back pressure.
27. Open (loosen) the bottom valve stem $\frac{1}{2}$ turn to initiate filtration as soon as possible.



Tip

Monitor the pressure gauges closely. If at any time during the test the pressure inside the cell rises above the setpoint, carefully open the needle valve on the manifold block just enough to bleed off the excess pressure. Then close the valve. If the cell pressure decreases due to collection of filtrate, increase the pressure with the top regulator.

28. To collect filtrate, carefully open the ball valve on the bottom of the back pressure receiver while holding a graduated cylinder up to the valve port. Close the valve immediately after the pressure begins to decrease and the filtrate is collected.



Note

Collect filtrate at 10 seconds, 1 minute, 7.5 minutes, and 30 minutes. The initial 10 second collection is precautionary in nature, as a fluid with little filtration properties may fill up the 15 mL receiver tube almost immediately, potentially damaging the regulator. Do not record the 10 second collection as a separate notation, but do record the volume collected at the other time intervals.

While collecting filtrate, maintain the test temperature within $\pm 5^{\circ}\text{F}$ ($\pm 3^{\circ}\text{C}$). If the back pressure rises during the test, cautiously reduce the pressure by opening the valve on the receiver and drawing off some of the filtrate into the graduated cylinder.

29. At the end of the test, close (tighten) the top and bottom valve stems to seal off the cell.
30. Turn both regulator T-screws counterclockwise to close off the flow of pressurized gas.
31. Open the outlet valve on the back pressure receiver to collect all of the remaining filtrate.
32. Open the bleeder valve on the manifold block to release any remaining pressure in the line.
33. Remove the manifold block and the back pressure receiver. Drain any residual filtrate from the receiver into the graduated cylinder.



Important

The heating jacket will still be very hot. Be careful not to touch it while removing the back pressure receiver.

34. Allow the cell to cool to room temperature.
35. Remove the cell from the heating jacket after once again checking that the valve stems are tightly closed.



Tip

An optional Cell Carrying Tool (#170-40) makes this a simple and safe operation.



Important

The test cell will still be under approximately 600 PSI (4.140 kPa) of pressure. To avoid possible injury, keep the cell upright and cool it to room temperature before disassembling. The cell must be cool for at least one hour at room temperature before loosening the locking screws and removing the cell cap.

36. Using extreme care to save the filter cake, place the cooled cell upright with the outlet side down. Slowly open (loosen) the inlet valve stem to bleed off pressure from the cell body.



Tip

Pressure cannot be relieved from the cell by opening the outlet valve stem as the filter cake will seal off the cell. It is a good idea to open the valve stem with the cell inside a sink or with a rag over the valve stem in order to catch any liquid that might be ejected.

37. Once the pressure is released, tighten the valve stem again to keep the fluid inside. Then turn the cell over.

38. Loosen the valve stem and unscrew and remove the outlet cell cap. Use the supplied cell cap wrench to loosen the threads.



Important

If the cell cap is difficult to unscrew, the pressure port may be clogged. Use the HTHP Pressure Relief Tool (170-91) to clear the obstruction.

39. Carefully remove the cement screen and deposited cake. Be careful not to damage the filter cake. Carefully wash any residual fluid from the surface of the filter cake.

40. Pour out the test fluid.

41. Clean and dry the apparatus thoroughly after each use. Inspect all of the o-rings and replace any that show signs of wear or damage.

Data

Filtrate Volume

The HTHP filter press has a filtration area of 3.55 in² (22.9 cm²). This is half the area of a standard filtration test, which is 7.1 in² (45.8 cm²). To compare the results of this test to a standard filtration test, double the total filtrate volume collected.

$$V_F = 2 (V_{30})$$

Where:

V_F = Standard Filtrate Volume (mL)

$V_{7.5}$ = Filtrate volume collected after 7.5 minutes

Spurt Loss (Optional):

Spurt Loss is the amount of filtrate collected before the filter cake has had a chance to form and is expressed in millimeters. To calculate the spurt loss, use the following equation:

$$V_1 = 2 [V_{7.5} - (V_{30} - V_{7.5})] = 2 (2V_{7.5} - V_{30}) = 4V_{7.5} - 2V_{30}$$

Where:

V_1 = Spurt Loss

$V_{7.5}$ = Filtrate volume collected after 7.5 minutes

V_{30} = Filtrate volume collected after 30 minutes

Filter Cake

Wash the filter cake on the paper with a gentle stream of water. Measure and report the thickness of the filter cake to the nearest 1/32 in (0.8 mm). A ruler with the "zero mark" at the very edge of the ruler is useful here. Cake descriptions may be subjective and such notations such as hard, soft, rubbery, and fine, etc. convey adequate information on cake quality.

Cell Cap Assembly



Tip

1. Choose the appropriate cap for your test:
 - 171-190-032-S - Outlet, for Cement
 - 171-190-033-S - Inlet, for Cement
2. Place the locking ring (#171-190-023) around the cap.
3. Place the retaining ring (#130-81-040) into the groove around the outside of the cap. Make sure it engages completely around the circle.

The cap should turn freely inside the locking ring.
4. Place an o-ring in the port in the cap. Wrap a rupture disk (#171-190-027) with nickel anti-seize tape (#171-190-040) and screw it into the port.



Locking Ring
(#171-190-023)

Retaining Ring
(#130-81-040)

Rupture Disk
(#171-190-027)

Cap

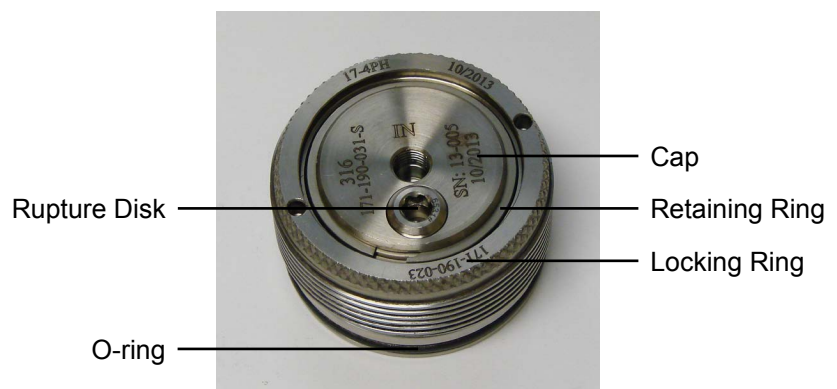

Maintenance

1. Thoroughly clean and dry all components with water and soap (or appropriate solvent).
2. Periodically check the cell assembly for leaks. Pressurize the cell and immerse it in water. Look for bubbles.
3. If the regulator loses pressure or steadily increases pressure, replace the seat assembly and diaphragm. Use the Regulator Repair Kit (#143-07). Always replace the rubber diaphragm (#143-00-1, sold separately). To replace the seat assembly:
 - a. Unscrew the spring case (housing cover). This may require a strap wrench.
 - b. Remove the spring case.
 - c. Remove the rubber diaphragm from inside the spring case.
 - d. Remove the thrust plate.
 - e. Using a wrench, loosen and remove the brass retainer.
 - f. The thrust pin and seat are now exposed. Remove them from the base.
 - g. Replace the spring.
 - h. Replace the seat holder.
 - i. Replace the thrust pin and the Teflon seat, which can be attached before insertion.
 - j. Replace the brass retainer with a wrench.
 - k. Replace the thrust plate with the curved edges downward.
 - l. Place a new rubber diaphragm inside the spring case.
 - m. Replace the spring case and hand tighten.

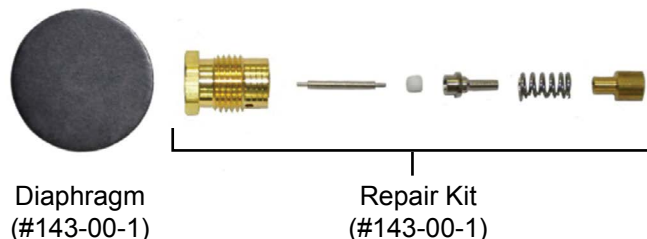

4. Power Cord

- a. Check the power cord for insulation wear and loose connections near the heating jacket and plug.
- b. Place the heating jacket no farther from the heating jacket than the length of the power cord.
- c. Keep the power cord away from the hot surface of the heating jacket.

Installing wiring, power cords, or electrical connectors will void the warranty.



Note

Regulator Maintenance and Troubleshooting

Symptoms	Cause: Resolution
Gas leak at the regulator outlet when the adjusting screw is loosened fully counterclockwise	Seat leak or *creep: Repair the regulator
Outlet pressure increases while downstream valves are closed	Seat leak or *creep: Repair the regulator
Gas leak from the spring housing case	Diaphragm failure: Repair the regulator
Excess drop in outlet pressure with the regulator flow open	Blocked seat assembly or inlet filter: Repair the regulator
Gas leak from any pipe thread joint	Loose fitting: Remove the connection. Clean the affected surfaces. Reapply Teflon tape and tighten.
Gas leak from relief valve	Faulty relief valve: replace the valve. Seat leak or *creep: Repair the regulator
Inconsistent repeat readings	Seat sticking: Repair the regulator. Bad pressure gauge: Replace the gauge.
Gauge does not return to zero with no pressure applied to the regulator.	Gauge has physical damage: Replace the gauge.
<p>*Creep is an increase in outlet pressure that occurs when pressure escapes even when the valve is closed. Regulator seats can be compromised by particles in the process stream which can cause minor imperfections in the sealing surface. The high flow and small orifice created during pressure regulation combine to turn a very small particle into a fast projectile. This projectile can nick the sealing surface of the seat and cause leaks. Filtering particulates from the process stream should be a high priority, and a small filter can reduce the potential for creep and increase the life expectancy and accuracy of the regulator.</p>	

Diagrams

Dual Nitrogen Manifold

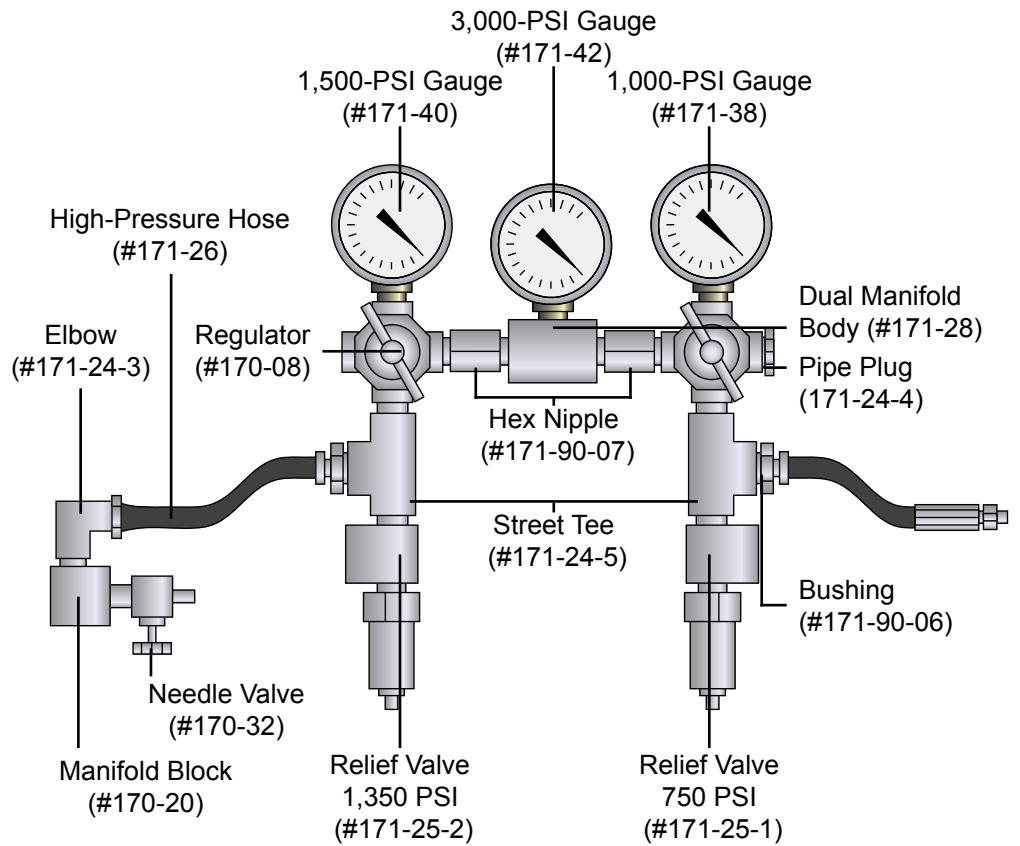

Diagrams

Test Cell

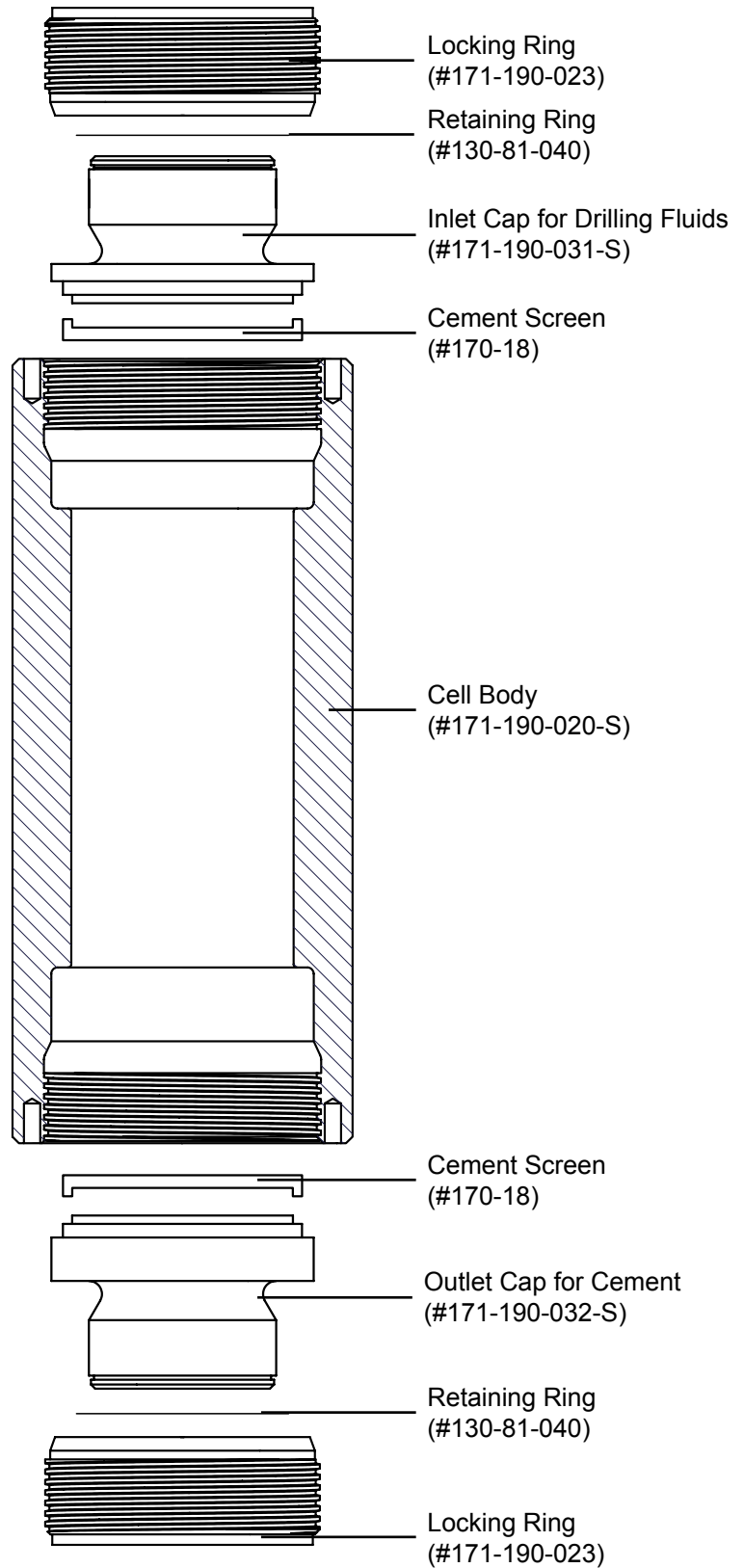

Warranty and Return Policy

Warranty:

OFI Testing Equipment, Inc. (OFITE) warrants that the products shall be free from liens and defects in title, and shall conform in all respects to the terms of the sales order and the specifications applicable to the products. All products shall be furnished subject to OFITE's standard manufacturing variations and practices. Unless the warranty period is otherwise extended in writing, the following warranty shall apply: if, at any time prior to twelve (12) months from the date of invoice, the products, or any part thereof, do not conform to these warranties or to the specifications applicable thereto, and OFITE is so notified in writing upon discovery, OFITE shall promptly repair or replace the defective products. Notwithstanding the foregoing, OFITE's warranty obligations shall not extend to any use by the buyer of the products in conditions more severe than OFITE's recommendations, nor to any defects which were visually observable by the buyer but which are not promptly brought to OFITE's attention.

In the event that the buyer has purchased installation and commissioning services on applicable products, the above warranty shall extend for an additional period of twelve (12) months from the date of the original warranty expiration for such products.

In the event that OFITE is requested to provide customized research and development for the buyer, OFITE shall use its best efforts but makes no guarantees to the buyer that any products will be provided.

OFITE makes no other warranties or guarantees to the buyer, either express or implied, and the warranties provided in this clause shall be exclusive of any other warranties including ANY IMPLIED OR STATUTORY WARRANTIES OF FITNESS FOR PURPOSE, MERCHANTABILITY, AND OTHER STATUTORY REMEDIES WHICH ARE WAIVED.

This limited warranty does not cover any losses or damages that occur as a result of:

- Improper installation or maintenance of the products
- Misuse
- Neglect
- Adjustment by non-authorized sources
- Improper environment
- Excessive or inadequate heating or air conditioning or electrical power failures, surges, or other irregularities
- Equipment, products, or material not manufactured by OFITE
- Firmware or hardware that have been modified or altered by a third party
- Consumable parts (bearings, accessories, etc.)

Returns and Repairs:

Items being returned must be carefully packaged to prevent damage in shipment and insured against possible damage or loss. OFITE will not be responsible for equipment damaged due to insufficient packaging.

Any non-defective items returned to OFITE within ninety (90) days of invoice are subject to a 15% restocking fee. Items returned must be received by OFITE in original condition for it to be accepted. Reagents and special order items will not be accepted for return or refund.

OFITE employs experienced personnel to service and repair equipment manufactured by us, as well as other companies. To help expedite the repair process, please include a repair form with all equipment sent to OFITE for repair. Be sure to include your name, company name, phone number, email address, detailed description of work to be done, purchase order number, and a shipping address for returning the equipment. All repairs performed as "repair as needed" are subject to the ninety (90) day limited warranty. All "Certified Repairs" are subject to the twelve (12) month limited warranty.

Returns and potential warranty repairs require a Return Material Authorization (RMA) number. An RMA form is available from your sales or service representative.

Please ship all equipment (with the RMA number for returns or warranty repairs) to the following address:

OFI Testing Equipment, Inc.
Attn: Repair Department
11302 Steeplecrest Dr.
Houston, TX 77065
USA

OFITE also offers competitive service contracts for repairing and/or maintaining your lab equipment, including equipment from other manufacturers. For more information about our technical support and repair services, please contact techservice@ofite.com.